

Model : ALP024-R

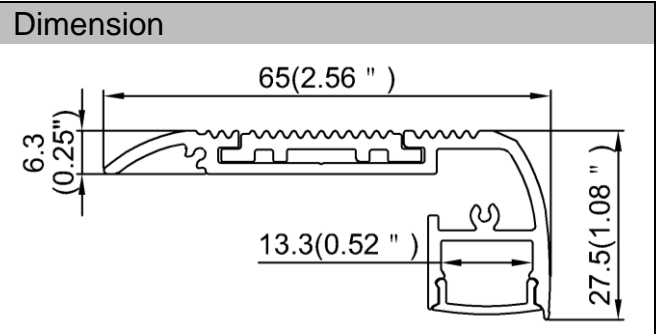

### Specification

Aluminum Profile	6065-T5
Diffuser	PC diffused cover / PMMA opal matte cover / PMMA semi-clear cover
Length	2000mm / 2500mm / 3000mm
Weight	0.712 kg/m
Max LED Strip Width	12mm
Max Power	18W/m
Beam angle	100°
Finish	Silver / Black anodized , Powder coated white / black or other colors
Installation	Surface

### Accessories



End Cap with hole (Metal)



End Cap without hole (Metal)

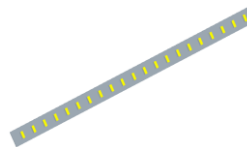

LED strip



Blind PVC cover(PVC)

### Steps of Installation

1. Stick the LED strip & click the cover

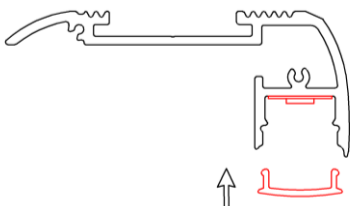

2. Install the end caps

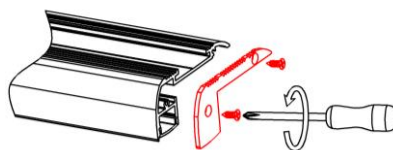

3. Mounting the profile

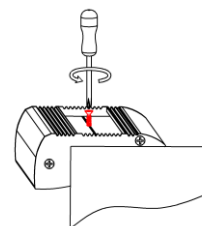

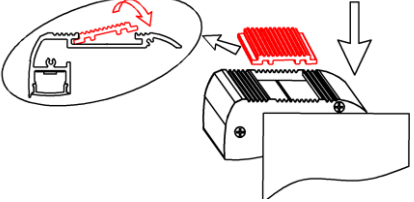
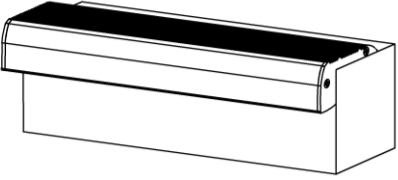
<p>4. Install the blind PVC cover</p> 	<p>1. Installation completed</p> 	
---	--	--